



XTi-VBox TV Gateway

33xx family Quick Installation



Product Version: 1.0
Release Date: Jan 2014
Document Revision: 1.3

of specified style in document.

Contents

1	Introduction to XTi-VBox TV Gateway	2
1.1	XTi-VBox TV Gateway 33XX family Product Line.....	2
2	Quick Installation for XTi	3
3	Front and Rear Panels	4
3.1	Front Panel	4
3.2	Rear Panels	5
3.2.1	XTi-3330 Dual Tuner Rear Panel	6
3.2.2	XTi-3332/3332 CI Unicable Rear Panel	7
3.2.3	XTi-3340-50/3340-50 CI Rear Panel	8
3.2.4	XTi-3342-52 CI Rear Panel	9

1 Introduction to XTi-VBox TV Gateway

XTi-VBox TV Gateway is a set-top box that gives you the freedom to consume all types of television broadcasts - satellite (DVB-S), cables (DVB-T) and terrestrial (DVB-T), as well as video - through a single media gateway.

XTi-VBox TV Gateway eliminates the constraints to physical cables, by using an IP infrastructure.

You can receive different types of media from various sources, and share them with any computer, laptop, tablet, Smartphone, or IP-STB device connected to your Local Area Network (LAN).

1.1 XTi-VBox TV Gateway 33XX family Product Line

XTi-VBox TV Gateway includes several products: XTi-3330, XTi-3332, XTi-3340 and XTi-3342. Each product is available in one or more models. Table 1 lists the products and their models and summarizes their specifications.

Table 1: XTi-VBox TV Gateway Product List and Specifications

Product Name 33XX family	Model Name	Supported Broadcasts	serve users simultaneously	RF Connectors	CI
XTi-3330	Dual Tuner 2S	2 Satellite	2	2	-
XTi-3332	Unicable 4S	4 Satellite	4	1	-
XTi-3332 CI	Unicable 4S	4 Satellite	4	1	+
XTi-3340	2S-2T/2C	2 DVB-T & 2 Satellite	4	3	-
XTi-3340 CI	2S-2T/2C	2 DVB-T & 2 Satellite	4	3	+
XTi-3342 CI	Dual Tuner 2T/2C	2 DVB-T	2	1	+
XTi-3350	2S-2C	2 DVB-C & 2 Satellite	4	3	-
XTi-3350 CI	2S-2C	2 DVB-C & 2 Satellite	4	3	+
XTi-3352 CI	Dual Tuner 2C	2 DVB- C	2	1	+

2 Quick Installation for XTi Using Tablet or PC

Tablet	PC
<p><u>Connect the devise</u></p> <p>Connect the devise Wired to your Home router</p> <p>Connect antenna Cable see rear panel option 3.2</p> <p>Connect power Cable</p> <p>Power On the device</p>	<p><u>Connect the devise</u></p> <p>Connect the devise Wired to your Home router</p> <p>Connect antenna Cable see rear panel option 3.2</p> <p>Connect power Cable</p> <p>Power On the device</p>
<p>Download VBox Apps on our website</p> <p>Open the apps on you Tablet.</p> <p>The apps will find the device</p> <p>Click on the device</p>	<p>Go to “ My Computer”</p> <ul style="list-style-type: none"> - Network - right click on the device Name <p>Select first option : “ view device webpage”</p>
<p>Click on TV Gateway Settings</p> <p>Click on Quick Setup and follow the instruction.</p>	<p>Click on Quick setup</p> <p>Follow the instruction</p>
<p><u>Players-</u> reopen _VBox Apps and enjoy</p> <p>Additional information regarding the possible can be found at VBox site or in full user guide</p>	<p><u>Players-</u></p> <p>Additional information regarding the possible can be found at VBox site or in full user guide</p>

3 Front and Rear Panels

This section describes the front and rear panels of the XTi-VBox TV Gateway set-top box.

3.1 Front Panel

All XTi-VBox TV Gateway products share the same front panel, illustrated in Figure 1.

Figure 1: XTi Front Panel

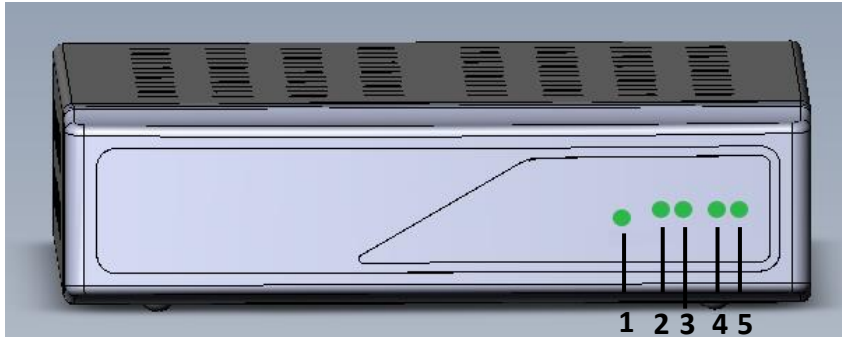

Table 2: XTi Front Panel

Item	Description
1	Power LED – indicates whether the system is ready: <ul style="list-style-type: none">▪ Orange–indicates the system is connected to electricity but is still in the process of being started.▪ Green– indicates the XTi device is ready for use.
2-5	Tuner LEDs – indicate the traffic status in tuners 1-4: <ul style="list-style-type: none">▪ Steady green light– indicates a locked frequency.▪ Blinking green light– indicates this tuner is transmitting data.

3.2 Rear Panels

This section describes the rear panel of each XTi-VBox TV Gateway product:

- XTi-3330 Dual Tuner Rear Panel
- XTi-3330 Dual Tuner Rear Panel
- TheXTi-3330 Dual Tuner 2Smodel includes two active RF connectors: one for each satellite tuners.

Figure 2: XTi 3330 Dual Tuner (Model Dual Tuner 2S) – Rear Panel

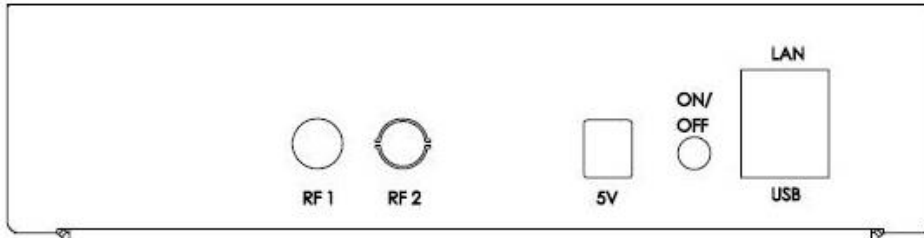

Item	Description
1	RF1 – Connector for Tuner-1 DVB-S/S2
2	RF2 –Connector for Tuner-2 DVB-S/S2
3	5V –power adapter connector
4	ON/OFF – Power button
5	LAN – RJ45 1 GB (Ethernet cable) connector
6	USB – USB Connector

Diagram 1: XT1 3330 Dual Tuner – Two Connectors: One for Each Satellite Tuner

- XTi-3332/3332 CI Unicable Rear Panel
- XTi-3340-50/3340-50 CI Rear Panel
- XTi-3340-50/3340-50 CI Rear Panel

3.2.1 XTi-3330 Dual Tuner Rear Panel

The XTi-3330 Dual Tuner 2S model includes two active RF connectors: one for each satellite tuner.

Figure 2: XTi 3330 Dual Tuner (Model Dual Tuner 2S) – Rear Panel

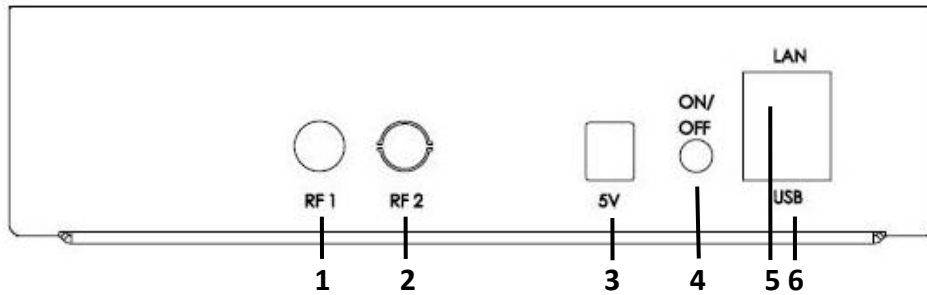

Item	Description
1	RF1 – Connector for Tuner-1 DVB-S/S2
2	RF2 –Connector for Tuner-2 DVB-S/S2
3	5V –power adapter connector
4	ON/OFF – Power button
5	LAN – RJ45 1 GB (Ethernet cable) connector
6	USB – USB Connector

Diagram 1: XTi 3330 Dual Tuner – Two Connectors: One for Each Satellite Tuner

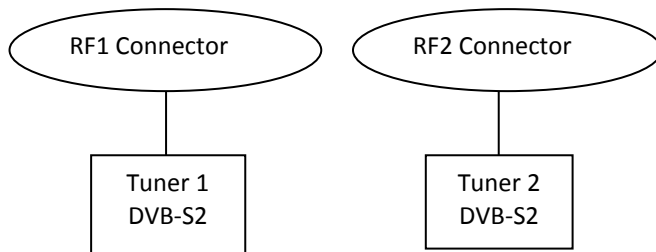

3.2.2 XTi-3332/3332 CI Unicable Rear Panel

XTi-3332 Unicable models (4S and 4S CI) have a rear panel with one RF connector for all satellite tuners. Note that the second RF connector is not in use.

Figure 3: XTi 3332 Unicable (Models Unicable 4S CI & Unicable 4S)–Rear Panel

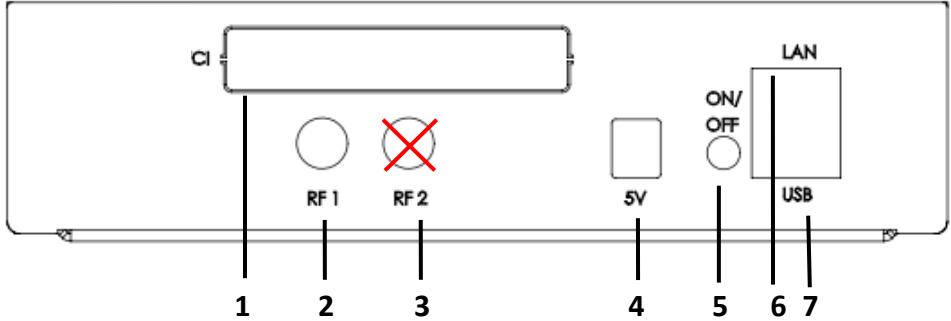

Item	Description
1	CI –Optional 2 CAM slot * 3332 CI
2	RF1–Connector for tuner-1 DVB-S2 (see diagram 1 below)
3	RF2–Connector for tuner-2 DVB-S2, NOT IN USE
4	5V–Power adapter connector
5	ON/OFF–Power button
6	LAN–RJ45 1 GB (Ethernet cable) connector
7	USB –USB Connector

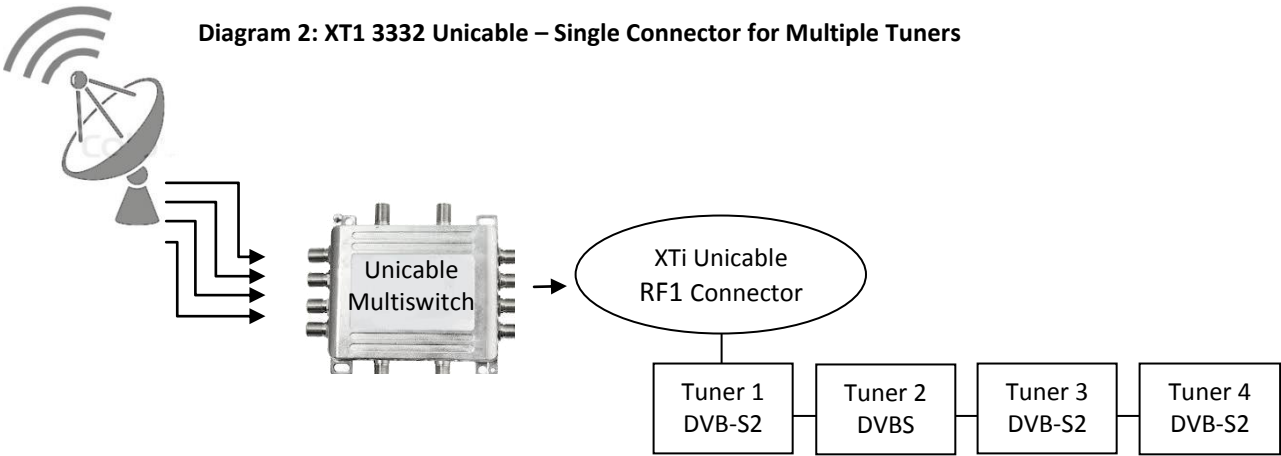

3.2.3 XTi-3340-50/3340-50 CI Rear Panel

The XTi-3340 rear panel includes two satellite tuners and two DVB-T or two DVB-C tuners.

Figure 4: XTi 3340-50 (Models 2S-2T/2C CI & 2S-2T/2C) – Rear Panel

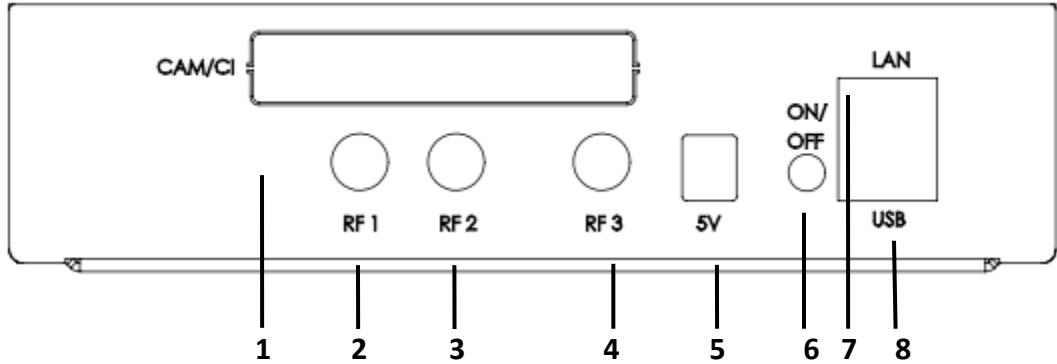

Item	Description
1	CAM/CI – Optional CI slot for DVB-T/C RF-3 only
2	RF1 – Connector for Tuner-1 DVB-S2
3	RF2 –Connector for Tuner-2 DVB-S
4	RF 3 – Connector for Tuner-3 DVB-T/C and tuner 4 DVB-T/C
5	5V – DC power adapter connector
6	ON/OFF – Power button
7	LAN – RJ45 1 GB (Ethernet cable) connector
8	USB – USB Connector

See diagram3 bellow

Diagram 3: XT1 3340 Connectors and Tuners

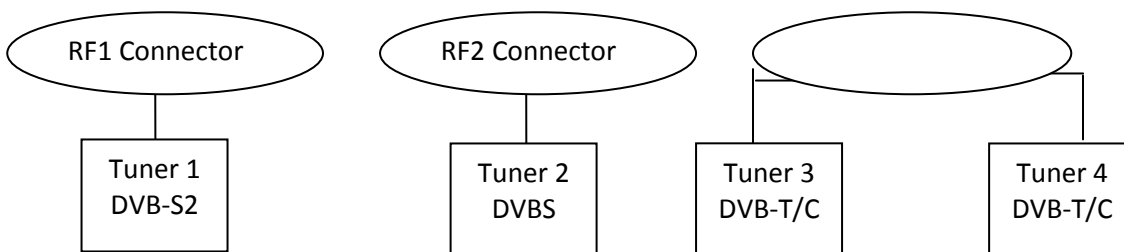

3.2.4 XTi-3342-52 CI Rear Panel

XTi-3342-52 Dual Tuner 2T/2C has a rear panel with a single connector (RF3) for either two DVB-T tuners or two DVB-C tuners (Figure 5). (See How to switch between DVB-T and DVB-C Configuration Paragraph 14.1)

Figure 5: XTi 3342 Dual Tuner (Model 2T/2C) – Rear Panel

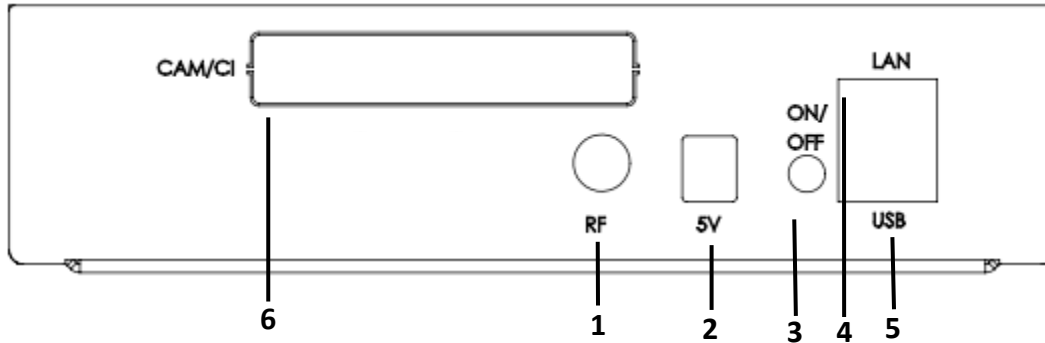

Item	Description
1	RF – Connector for 2* Tuner (DVB-T/C) (See diagram 3 below)
2	5V –power adapter connector
3	ON/OFF – Power button
4	LAN – RJ45 1 GB (Ethernet cable) connector
5	USB – USB Connector
6	CAM/CI – Optional CI slot for DVB-T/C

Diagram 4: XT1 3342 - Dual Tuner 2T/2C: Single Connector for Two DVB-T or DVB-C Tuners

